

Article number: 12857000080860
Description: KLEE-coil 857 000 080.860
M8 Brass

Measures

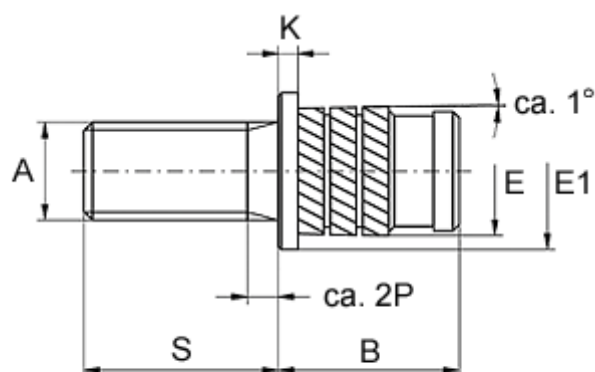

Gevindlængde = $S - 2P$
P = stigning

Flange diameter E1	= 11.0
Flange height	= 1.3
Male thread A	= M8x1,25
Min distance to edge	= 3.8
Mounting length B	= 9.2
Outer diameter E	= 9.70
Pin length S	= 16
Recommended bore diameter	= 9.3